

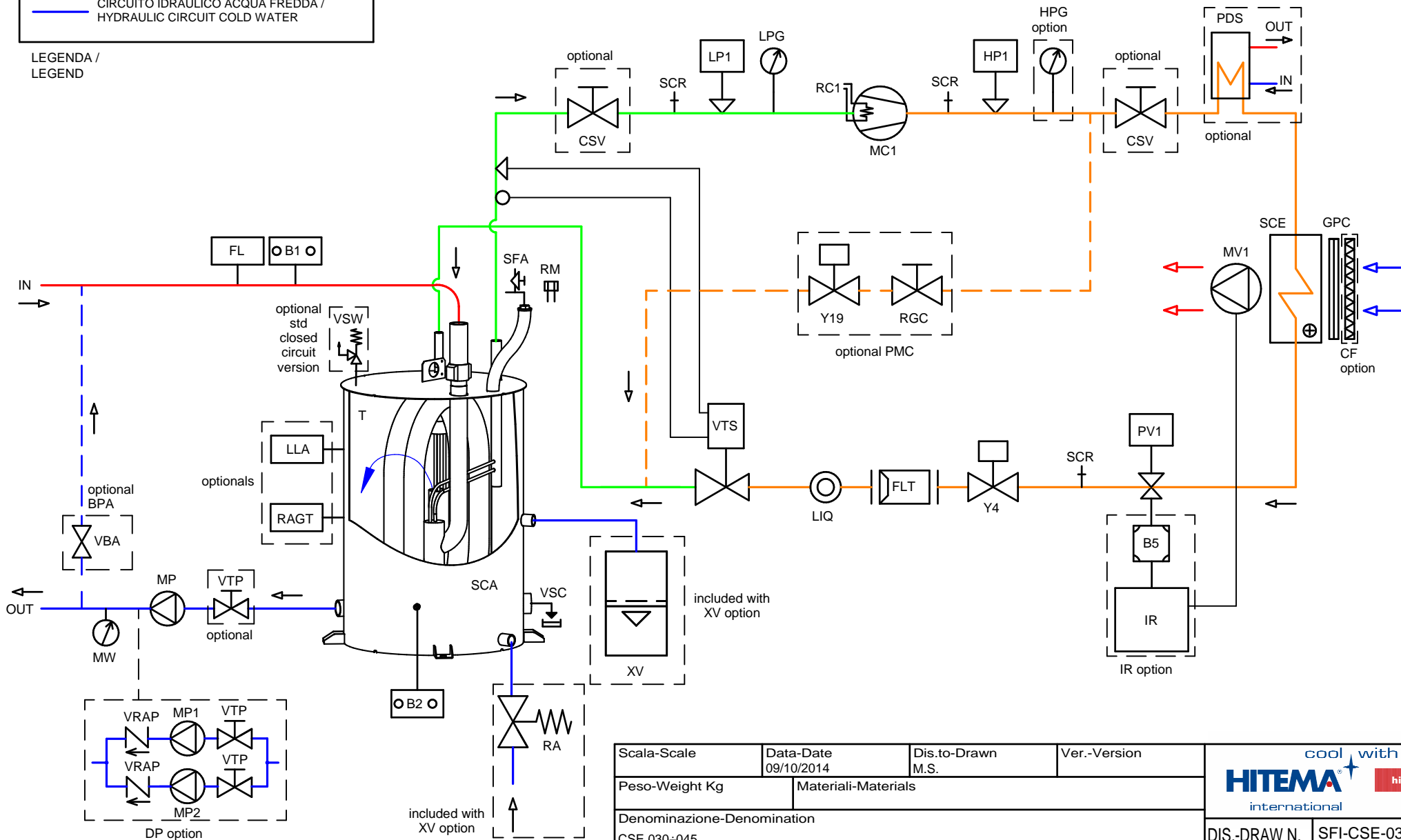

- CIRCUITO FRIGORIFERO ALTA PRESSIONE / HIGH PRESSURE REFRIGERANT CIRCUIT
- CIRCUITO FRIGORIFERO BASSA PRESSIONE / LOW PRESSURE REFRIGERANT CIRCUIT
- CIRCUITO IDRAULICO ACQUA CALDA / HYDRAULIC CIRCUIT WARM WATER
- CIRCUITO IDRAULICO ACQUA FREDDA / HYDRAULIC CIRCUIT COLD WATER



LEGENDA /  
LEGEND



Scala-Scale	Data-Date 09/10/2014	Dis.to-Drawn M.S.	Ver.-Version	
Peso-Weight Kg	Materiali-Materials			
Denominazione-Denomination CSE.030-045				DIS-DRAW N. SFI-CSE-030ST01
Particolare-Detail SCHEMA FRIGORIF./IDRAULICO HYDRAULIC/REFRIGERATING DIAGRAM				REVISIONE 02 - 09/10/2015 M.S.
FOGLIO/SHEET 1/3				PROGRAM. N.

## CIRCUITO IDRICO / HYDRAULIC CIRCUIT

SIGLA	DESCRIZIONE	DESCRIPTION	MODELS
FL	FLUSSOSTATO	FLOW SWITCH	std
B1	TEMPERATURA ACQUA INGRESSO EVAPORATORE	EVAPORATOR INLET TEMPERATURE SENSOR	std
SCA	SCAMBIATORE DI CALORE AD ACQUA (EVAPORATORE COASSIALE)	WATER HEAT EXCHANGER (COAXIAL EVAPORATOR)	std
B2	TEMPERATURA ACQUA USCITA EVAPORATORE	EVAPORATOR OUTLET TEMPERATURE SENSOR	std
T	SERBATOIO DI ACCUMULO	TANK	std
RM	TAPPO DI RIEMPIMENTO MANUALE	MANUAL FILLING CAP	std
VSW	VALVOLA SICUREZZA ACQUA	SAFETY WATER VALVE	std in closed circuit version
VSC	VALVOLA DI SCARICO ACQUA	DISCHARGE WATER VALVE	std
SFA	SFIATO ARIA	AIR VENT	manual for std (automatic with XV option)
LLA	ALLARME BASSO LIVELLO ACQUA	ELECTRIC FLOAT LOW LEVEL ALARM	optional
RAGT	RESISTENZA ANTIGELO VASCA	ANTIFREEZE HEATER INERTIAL TANK	optional
XV	VASO DI ESPANSIONE	EXPANSION VESSEL	optional (included in the XV option)
RA	RIEMPIMENTO AUTOMATICO CON VALVOLA DI RITEGNO E FILTRO INCLUSO	AUTOMATIC FEEDER WITH CHECK VALVE AND FILTER INCORPORATED	optional (included in the XV option)
MP	ELETTROPOMPA DI PROCESSO	PROCESSING PUMP	std
MW	MANOMETRO ACQUA	WATER PRESSURE GAUGE	std
VBA	VALVOLA DI BYPASS AUTOMATICO	AUTOMATIC BYPASS VALVE	optional (included in the BPA option)
BPA	BYPASS AUTOMATICO	AUTOMATIC BYPASS	optional
VTP	VALVOLA DI INTERCETTAZIONE TRA VASCA E POMPA	SHUT OFF VALVE BETWEEN TANK AND PUMP	optional
MP1-MP2	ELETTROPOMPA DI PROCESSO	PROCESSING PUMP	optional (included in the DP option)
VRAP	VALVOLA DI NON RITORNO ACQUA	NO RETURN WATER VALVE	optional (included in the DP option)



	CIRCUITO IDRAULICO ACQUA CALDA / HYDRAULIC CIRCUIT WARM WATER
	CIRCUITO IDRAULICO ACQUA FREDDA / HYDRAULIC CIRCUIT COLD WATER

LEGENDA /  
LEGEND

Scala-Scale	Data-Date 09/10/2014	Dis.to-Drawn M.S.	Ver.-Version		
Peso-Weight Kg	Materiali-Materials				
Denominazione-Denomination CSE.030-045				DIS.-DRAW N.	SFI-CSE-030ST01
Particolare-Detail SCHEMA FRIGORIF./IDRAULICO HYDRAULIC/REFRIGERATING DIAGRAM				REVISIONE	02 - 09/10/2015 M.S.
FOGLIO/SHEET 2/3				PROGRAM. N.	

CIRCUITO FRIGORIFERO STANDARD / STANDARD REFRIGERATING CIRCUIT

SIGLA	DESCRIZIONE	DESCRIPTION	MODELS	
MC1	COMPRESSORE	COMPRESSOR	std	
RC1	RESISTENZA CARTER COMPRESSORE	COMPRESSOR CRANKCASE HEATER	std	
SCR	VALVOLA DI CARICO SCHRADER	CHARGE VALVE (SCHRADER)	std	
HP1	PRESSOSTATO ALTA PRESSIONE	HIGH PRESSURE SWITCH	std	
HPG	MANOMETRO ALTA PRESSIONE	HIGH PRESSURE GAUGE	optional	
CSV	VALVOLA DI INTERCETTAZIONE COMPRESSORI	COMPRESSORS SHUT OFF VALVE	optional	
PDS	DESURRISCALDATORE PARZIALE	PARTIAL DESUPERHEATER	optional	
SCE	SCAMBIATORE DI CALORE AD ARIA (CONDENSATORE)	AIR HEAT EXCHANGER (CONDENSER)	std	
GPC	GRIGLIA PROTEZIONE CONDENSATORE	CONDENSER GRID PROTECTION	std	
CF	FILTRO ARIA CONDENSATORE	AIR CONDENSER FILTER	optional	
MV1	MOTOVENTILATORE CENTRIFUGO	CENTRIFUGAL FAN MOTOR	std	
PV1	PRESSOSTATO VENTILATORI	FAN PRESSURE SWITCH	std	
B5	TRASDUTTORE ALTA PRESSIONE	HIGH PRESSURE TRASDUCER	optional (included in the RV option)	
IR	INVERTER VENTILATORI	INVERTER FAN SPEED REGULATOR	optional	
Y4	VALVOLA SOLENOIDE LIQUIDO CIRCUITO	SOLENOID-VALVE FOR LIQUID LINE	std	
FLT	FILTRO DISIDRATATORE CIRCUITO REFRIGERANTE	DEHYDRATING FILTER FOR LIQUID LINE	std	
LIQ	SPIA DI FLUSSO / INDICATORE DI LIQUIDO	LIQUID INDICATOR / SIGHT GLASS FOR LIQUID LINE	std	
VTS	VALVOLA DI ESPANSIONE TERMOSTATICA	THERMOSTATIC EXPANSION VALVE	std	
SCA	SCAMBIATORE DI CALORE AD ACQUA (EVAPORATORE COASSIALE)	WATER HEAT EXCHANGER (COAXIAL EVAPORATOR)	std	
CSV	VALVOLA DI INTERCETTAZIONE COMPRESSORI	COMPRESSORS SHUT OFF VALVE	optional	
SCR	VALVOLA DI CARICO SCHRADER	CHARGE VALVE (SCHRADER)	std	
LP1	PRESSOSTATO DI BASSA PRESSIONE	LOW PRESSURE SWITCH	std	
LPG	MANOMETRO BASSA PRESSIONE	LOW PRESSURE GAUGE	std	
PMC	BYPASS GAS CALDO	HOT GAS BYPASS	optional	
RGC	RUBINETTO GAS CALDO	HOT GAS SHUT OFF VALVE	optional (included in the PMC option)	
Y19	ELETTRIVALVOLA BYPASS GAS CALDO	HOT GAS BYPASS VALVE (SOLENOIDE VALVE)	optional (included in the PMC option)	

	CIRCUITO FRIGORIFERO ALTA PRESSIONE / HIGH PRESSURE REFRIGERANT CIRCUIT
	CIRCUITO FRIGORIFERO BASSA PRESSIONE / LOW PRESSURE REFRIGERANT CIRCUIT

LEGENDA /  
LEGEND

Scala-Scale	Data-Date 09/10/2014	Dis.to-Drawn M.S.	Ver.-Version		
Peso-Weight Kg	Materiali-Materials				
Denominazione-Denomination CSE.030-045				DIS.-DRAW N.	SFI-CSE-030ST01
Particolare-Detail SCHEMA FRIGORIF./IDRAULICO HYDRAULIC/REFRIGERATING DIAGRAM				REVISIONE	02 - 09/10/2015 M.S.
FOGLIO/SHEET 3/3				PROGRAM. N.	